

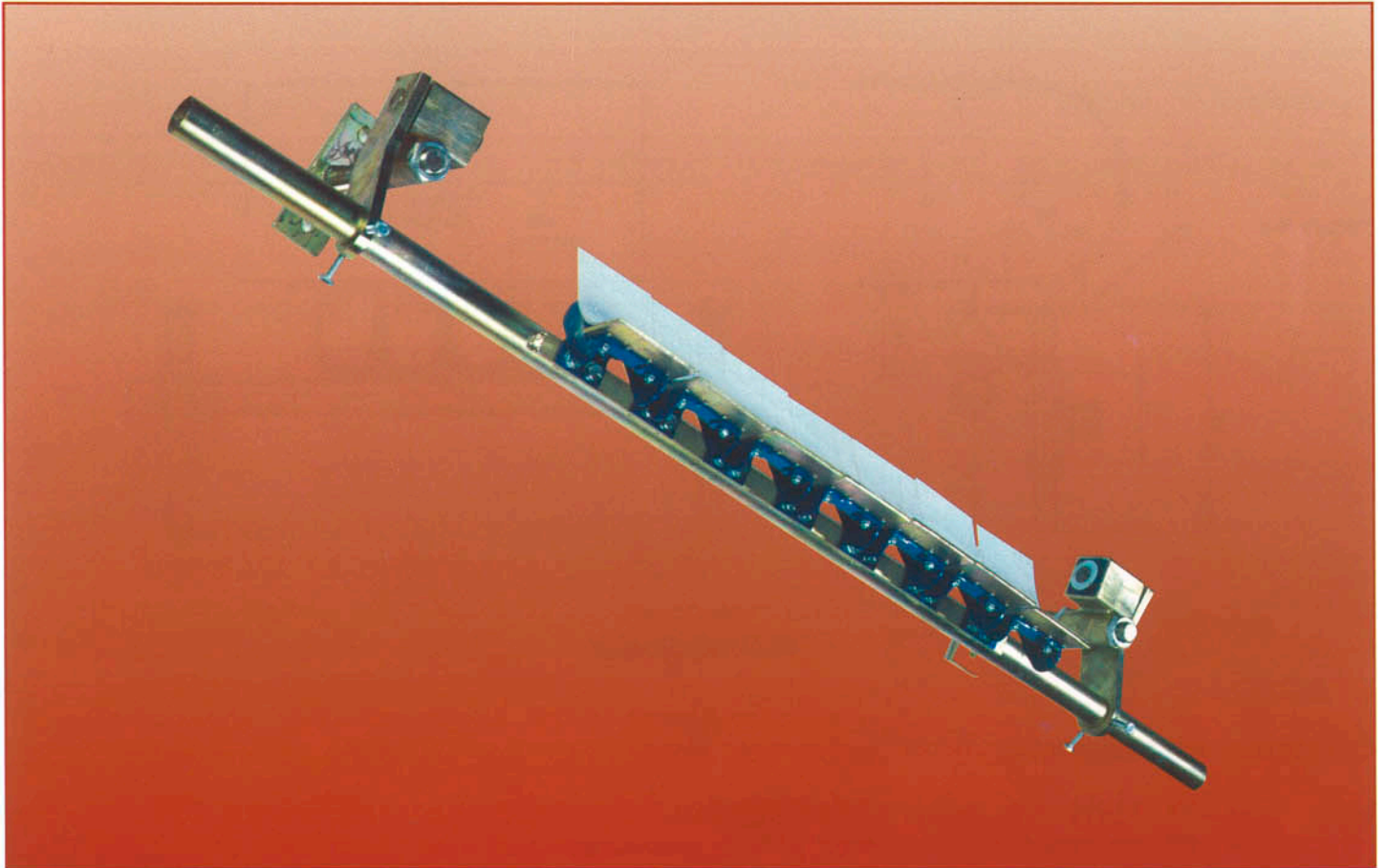











Canning Conveyor

Type MB Multiblade Scraper



-  cost effective and low maintenance
-  utilises proven belt cleaning technology
-  easy to install and maintain
-  torsion mounted for self adjusting
-  Hardened Steel blades for normal applications
-  Tungsten Carbide blades for abrasive applications
-  fully suitable for mechanical fasteners
-  modular scraper blades individually adjustable to accommodate belt wear
-  all metal parts zinc plated for protection



Canning Conveyor

Sandy Lane Industrial Estate, Sandy Lane, Worksop, Nottinghamshire
Tel: 01909 486166 . Fax: 01909 500638
e-mail: sales@canningconveyor.co.uk www.canningconveyor.co.uk



Canning Conveyor

Type MB Multiblade Scraper

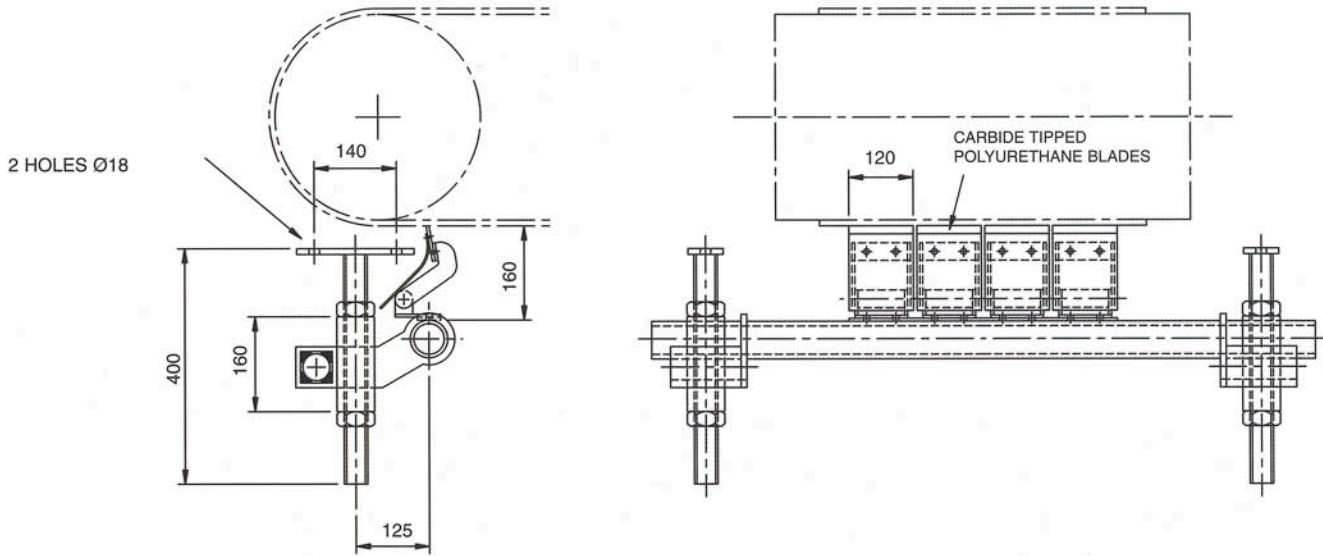

Multiblade Scraper

Ordering information

Note: **Type MB1** - Medium Duty, for belt widths up to 900mm
Type MB2 - Heavy Duty, for belt widths of 1000mm to 2000mm

Belt Width (mm)	450	500	600	650	750	800	900	1000/1050	1200	1350/1400	1500	1600	1800	2000
No. off Blades	3	4	4	5	6	6	7	8	9	10	12	13	14	16
Scraper Ref. with Hardened Steel blades	MB1/450HB	MB1/500HB	MB1/600HB	MB1/650HB	MB1/750HB	MB1/800HB	MB1/900HB	MB2/1000HB	MB2/1200HB	MB2/1400HB	MB2/1500HB	MB2/1600HB	MB2/1800HB	MB2/2000HB
Scraper Ref. with Tungsten Carbide blades	MB1/450T	MB1/500T	MB1/600T	MB1/650T	MB1/750T	MB1/800T	MB1/900T	MB2/1000T	MB2/1200T	MB2/1400T	MB2/1500T	MB2/1600T	MB2/1800T	MB2/2000T



Canning Conveyor

Sandy Lane Industrial Estate, Sandy Lane, Worksop, Nottinghamshire
 Tel: 01909 486166 . Fax: 01909 500638
 e-mail: sales@canningconveyor.co.uk www.canningconveyor.co.uk